

DTA04, DTA71, DTA72



Motor thermistor relay



Benefits

- **High operating safety.** The thresholds are determined by the Motor internal PTC. Beyond the specified temperature the output stops the motor/s.
- **Ensure continuous production process in your plant.** This type of controller allows limitation of false alarms which may be the cause of useless interruptions of production systems.
- **Output and status LED indication.** For quick troubleshooting.
- **Input for remote R / T button (DTA04, DTA72).** Input for remote periodical test and for reset of tripped relay after solved fault.

Description

DTA04, DTA71 and DTA72 are motor thermistor monitoring relays.

Through the motor internal PTC or PTCs the DTAs detect when one or more motor windings are exceeding the maximum operating winding temperature.

The PTC type installed in the motor is different according to the motor insulation temperature.

DTA04 and DTA72 can be set to operate as manual or auto reset .

Applications

This product is extremely suitable for pumps temperature monitoring. It can be useful in all applications where motors are used especially where overloads are frequent and may cause motor damages: pumping stations, water treatment, conveyors, material handling, HVAC, chillers, etc.

Main features

- Up to 6 PTCs in series can be connected.
- Test or reset push button (DTA04, DTA72).
- Auto reset (DTA71).



Order code

Mounting	Output	Power supply	Component name/part number
DIN-rail	2 x SPST relays	24 to 240 V AC/DC	DTA04DM24
	SPDT relay		DTA71CM24
	2 x SPDT relays		DTA72DM24

Structure

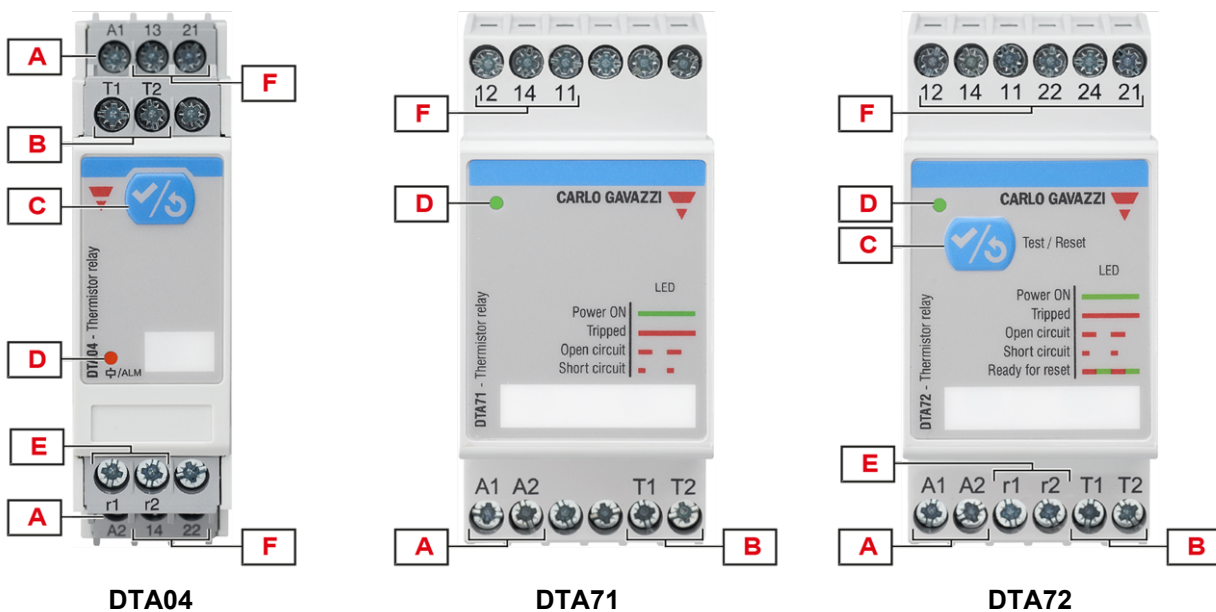

Element	Component	Function
A	Power supply terminals	A1, A2
B	PTC input	Up to 6 PTCs in series can be connected
C	Test / reset push button	When pressed it will test the system integrity or restores operation after an alarm has been triggered
D	Information LEDs	Green for device ON Red for signal alarm status Red and green alternate: ready for reset
E	Remote reset input	Restores operation after an alarm has been triggered
F	Output terminals	2 x SPST relay output (DTA04) SPDT relay output (DTA71) 2 x SPDT relay outputs (DTA72)

Features

Power supply

Power supply	Supplied by A1, A2
Voltage range	24 V -25% to 240 V +10% AC/DC (18 to 265 V AC/DC)
Overvoltage category	III
Frequency range	50 to 60 Hz \pm 10% sinusoidal waveform
Consumption	< 2 VA

Inputs

Remote reset input

Terminals	r1 ,r2
Typology	Input for push button
Switching frequency	\leq 1 Hz
Logic levels	Open state: > 10 k Ω Closed state: < 100 Ω
Refresh time	\leq 500 ms

PTC probe input

Terminals	T1, T2
Typology	Input for a series of 1 to 6 PTCs according to EN44081 or IEC34-11-2
Measured voltage	3.3 V
Resolution	1 Ω at short circuit detection value 10 Ω at over temperature reset value 50 Ω at over temperature trip value 1000 Ω at open circuit detection value
Accuracy	\pm 3 Ω at short circuit detection value \pm 30 Ω at over temperature reset value \pm 150 Ω at over temperature trip value \pm 3000 Ω at open circuit detection value
Refresh time	\leq 500 ms

Outputs

Terminals	13, 14, 21, 22 (DTA04) 11, 12, 14 (DTA71) 11, 12, 14, 21, 22, 24 (DTA72)
Number of outputs	1 (DTA71) 2 (DTA04, DTA72)
Type	SPDT electromechanical relay with changeover contacts (DTA71, DTA72) SPST electromechanical relay with normally open contacts (DTA04)
Logic	Output 1: de-energised on alarm Output 2: energised on alarm
Contact rating	AC1: 8 A @ 250 VAC DC12: 5 A @ 24 VDC AC15: 2.5 A @ 250 VAC DC13: 2.5 A @ 24 VDC
Electrical lifetime	$\geq 50 \times 10^3$ operations (at 8 A, 250 V, $\cos \varphi = 1$)
Mechanical lifetime	$> 30 \times 10^6$ operations
Assignment	Output 1: over temperature or probe connection fault alarms Output 2: over temperature or probe connection fault alarms

Insulation

Terminals	Basic insulation
Inputs: r1, r2, T1, T2 to output 1: 13, 14 (DTA04); 11, 12, 14 (DTA7x)	2.5 kVrms, 4 kV impulse 1.2/50 μ s
Inputs:r1, r2, T1, T2 to output 2: 21,22 (DTA04) 21, 22, 24 (DTA72)	
Inputs:r1, r2, T1, T2 to power supply: A1, A2	
Output 1: 13, 14 (DTA04); 11, 12, 14 (DTA72) to output 2: 21,22 (DTA04) 21, 22, 24 (DTA72)	
Output 1: 13, 14 (DTA04); 11, 12, 14 (DTA7x) to power supply: A1, A2	
Output 2: 21,22 (DTA04) 21, 22, 24 (DTA72) to power supply: A1, A2	

General

Material	Polyamide (Nylon) (PA66/6) or Phenylene ether + Polystyrene (PPE-PS)
	Flammability rating: V0 according to UL 94
Colour	RAL7035 (light grey)
Dimensions (W x H x D)	DTA7x: 35.5 x 81 x 67.2 mm (1.40 x 3.19 x 2.65 in)
	DTA04: 22.5 x 80 x 99.5 mm (0.89 x 3.15 x 3.92 in)
Weight	Approx. 150 g (5.29 oz)
Terminals	DTA04: cable size from 0.05 to 2.08 mm ² (AWG30 to AWG14), stranded or solid DTA7x: cable size from 0.06 to 3.3 mm ² (AWG30 to AWG12), stranded or solid
Tightening torque	DTA04: 0.5 Nm (4.425 lbin) DTA7x: 0.4 to 0.8 Nm (3.540 to 7.080 lbin)
Terminal type	Screw terminals (double cage for DTA04)

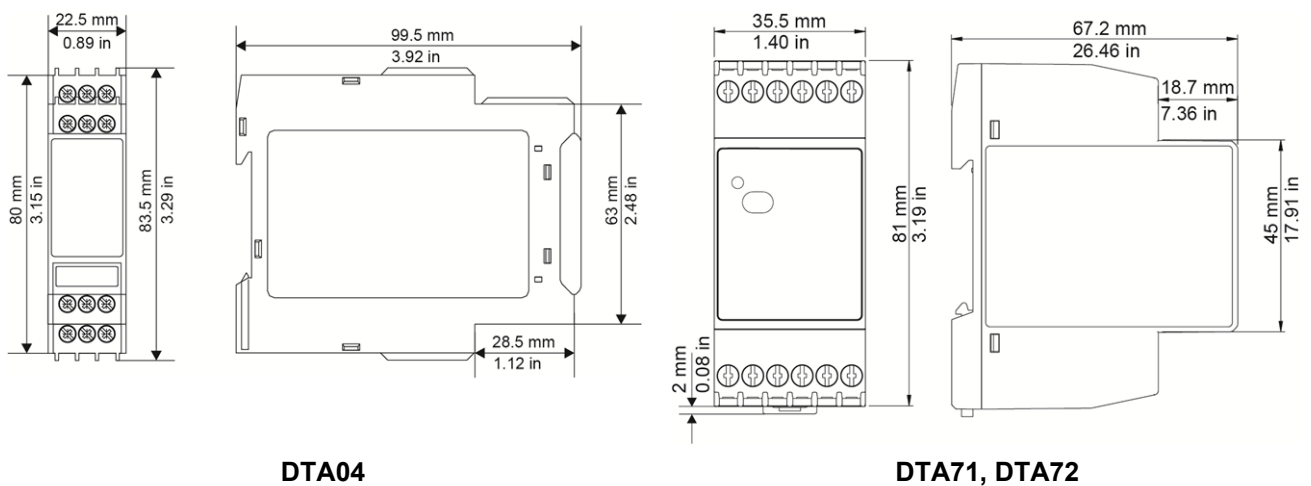

Environmental

Operating temperature	-25 to 60 °C (-13 to 140 °F)
Storage temperature	-40 to 80 °C (-40 to 176 °F)
Relative humidity	5 - 95% non condensing
Protection degree	IP20
Pollution degree	2
Operating max altitude	2000 m amsl (6560 ft)
Salinity	Non saline environment
UV resistance	No



Vibration/Shock resistance

Test condition	Test	Level
Tests with unpacked device	Vibration response (IEC60255-21-1)	Class 1
	Vibration endurance (IEC 60255-21-1)	Class 1
	Shock (IEC 60255-21-2)	Class 1
	Bump (IEC 60255-21-2)	Class 1
Tests with packed device	Vibration random (IEC60068-2-64)	Class 1
	Shock (IEC 60255-21-2)	Class 1
	Bump (IEC 60255-21-2)	Class 1

Class 1: monitoring devices for normal use in power plants, substations and industrial plants and for normal transportation conditions.

The packaging type is designed and implemented in such manner that the severity class parameters will not be exceeded during transportation.

Compatibility and conformity

Marking	 
Directives	2014/35/EU (LVD - Low voltage) 2014/30/EU (EMC - Electromagnetic compatibility) 2011/65/EU, 2015/863/EU (RoHS)
Standards	EN 60947-8 EN 60947-5-1 EN 63000: 2018
Approvals	

Operating description

Device configuration

DTA04 or DTA72

When the temperature of one of the PTCs in series is exceeded or the probe connection is interrupted, both output relays switch: output relay 1 is de-energised and output relay 2 is energised.

When normal motor temperature or probe connection is restored, if the DTA04 / DTA72 is wired as "auto reset", the operation is restarted automatically.

If the DTA04 / DTA72 is wired as manual reset, when normal motor temperature or probe connection is restored, it is ready for reset. When the front or the remote RESET buttons are pressed the operation starts again. The output relays switch back to original position.

DTA71

When the temperature of one of the PTCs in series is exceeded or the probe connection is interrupted, the output relay is de-energised.

When normal motor temperature or probe connection is restored, the output relay is energised again ("auto reset").

Alarms

DTA's operate in 2 different modes depending upon the alarm type:

- Over temperature.
- Probe connection fault.

Over temperature alarm	
Input variables	PTC input, local test/reset button, remote reset button
Alarm setpoint	3600 Ω
Restore setpoint	1580 Ω
Reaction time	≤ 500 ms
Delay ON	None
Delay OFF	None

Probe connection fault alarm	
Input variables	PTC input, local test/reset button, remote reset button
Alarm setpoint	Open circuit value: ≥ 20 k Ω Short circuit value: ≤ 14 Ω
Restore setpoint	Reset from open circuit: ≤ 18 k Ω Reset from short circuit: ≥ 16 Ω
Reaction time	≤ 500 ms
Delay ON	None
Delay OFF	None

Information LEDs

Colour	Status	Description	
Green (\odot) / Red (ALM)	Power supply/ Alarm status	Green	Power supply ON
		Red fixed	Over temperature alarm
		Red blink 2 Hz	PTC open circuit
		Red blink 1.5 Hz	PTC short circuit
		Red/green blink	Ready for reset



Operating diagram

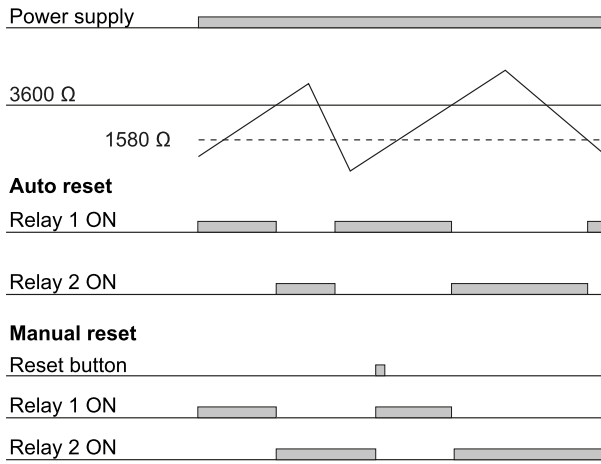

DTA04, DTA72

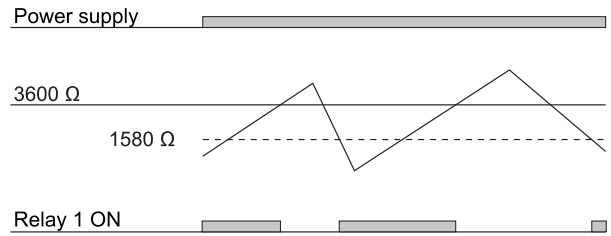

DTA71

Connection diagrams

(*) NOTE: fuses F of 315 mA delayed, if required by local law.

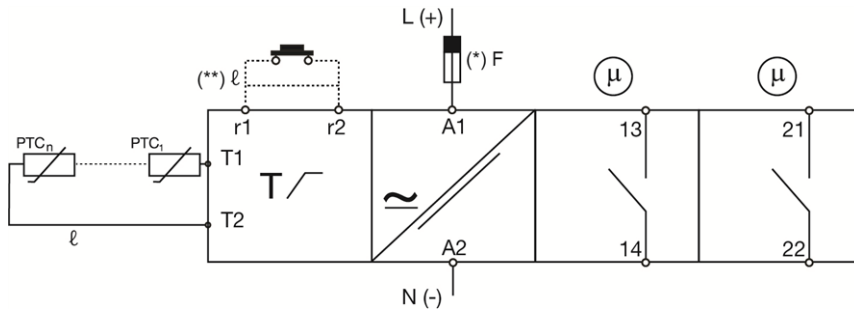

DTA04

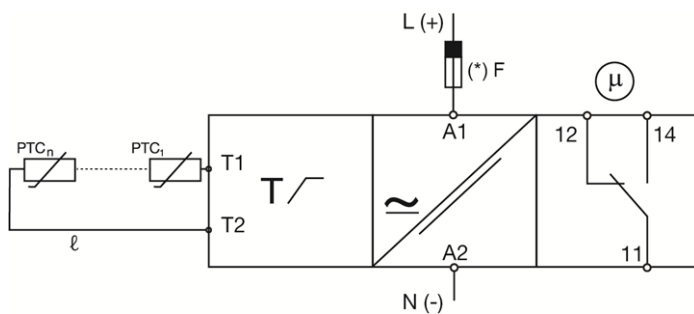

DTA71

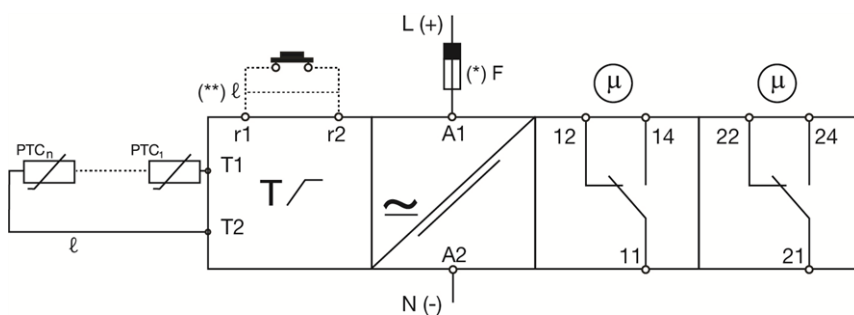

DTA72

Cable size Ø	0.5 mm ²	0.75 mm ²	1 mm ²	1.5 mm ²
Cable length (ℓ)	200 m	300 m	400 m	600 m

< 200 m twisted pair

> 200 m shielded twisted pair

PTC according to IEC 60034-11

References

Further reading

Information	Where to find it	QR code
DTA04 installation manual	https://www.gavazziautomation.com/fileadmin/images/PIM/MANUALS/ENG/DTA04_IM.pdf	
DTA71/72 installation manual	https://www.gavazziautomation.com/fileadmin/images/PIM/MANUALS/ENG/DTA_71_72_IM.pdf	
PSS selection tool	https://carlogavazzi-pss.com/	



COPYRIGHT ©2024

Content subject to change. Download the PDF: www.gavazziautomation.com