



NRG controller with Modbus RTU over RS485



Main features

- **Communication interface.** The NRG controller bridges the field level devices to the control level to allow exchange of data in real-time with the NRG solid state relays.
- **Reduced maintenance costs and downtime.** Use of real-time data for prevention of machine stoppages during operation.
- **Good quality products and low scrap rates.** Real-time monitoring allows timely decisions for better machine and process management.
- **Reduced efforts in troubleshooting.** A number of faults can be distinguished to facilitate and reduce troubleshooting time.
- **Fast installation and set-up.** The solid state relays on the BUS are configured by AutoConfiguration for fast set-up and prevention of incorrect settings.
- **Compact dimensions.** One controller with a product width of 35 mm can handle up to 32 RG..CM..N or 48 RG..D..N NRG solid state relays.

Description

The **NRGC** is the NRG controller in the NRG BUS chain.

The **NRGC** interfaces directly with the main controller of the system through Modbus RTU on an RS485 interface. Each **NRGC** in the system is identified by a unique Modbus address that can be set either manually via a front selector switch that allows only Modbus addresses 1 to 15 or through dedicated registers for addresses 1 to 247. The default Modbus communication settings can also be modified via dedicated registers.

The **NRGC** acts as a master of the respective NRG BUS chain when it is requested by the main controller to carry out actions on the specific NRG BUS chain. Otherwise, the **NRGC** is just a facilitator of the communication between the main controller and each individual **RG..N** solid state relay in the system.

The **NRGC** needs to be supplied with 24 VDC. It is equipped with a configurable digital output that is set as an **NRGC** alarm indication as the default setting. LEDs on the front facade give a visual indication of the status of the NRGC, of any ongoing communication with the main controller (COM) and the RG..Ns on the BUS chain (BUS) and of any alarm condition related specifically to the **NRGC**.

Specifications are noted at 25°C unless otherwise specified.

Applications

Any heating application where reliable and precise maintenance of temperatures is crucial to the quality of the end product. Typical applications include plastic machinery such as injection machines, extrusion machines and PET blow moulding machines, packaging machinery, sterilisation machinery, drying tunnels and semiconductor manufacturing equipment.

Main function

- Communication interface: Modbus over RS485
- Connects up to 48 **RG..D..Ns** or 32 **RG..CM..Ns**
- Selector switch for Modbus addresses 1-15 (Modbus addresses 1-247 through comms)
- Supply voltage 24 VDC +/-20%

The NRG system

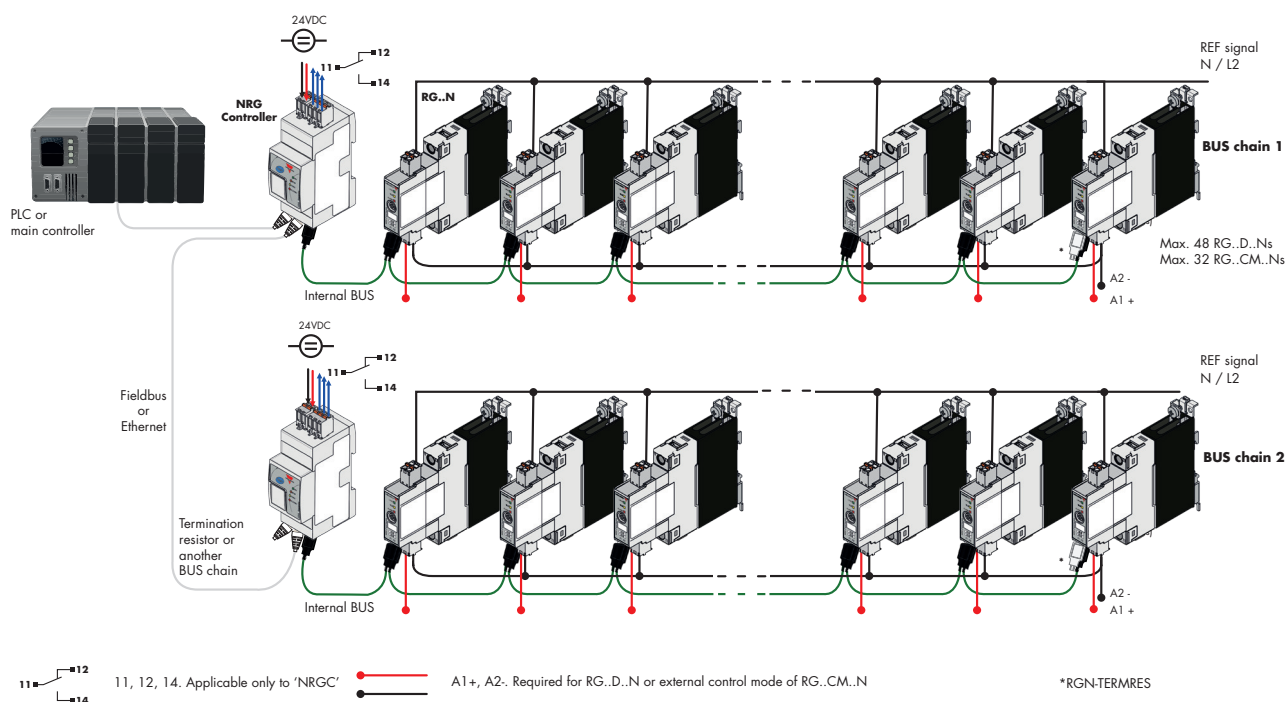

System Overview

The NRG is a system consisting of one or more BUS chains that enable communication between the field devices (such as the solid state relays) and the control devices (such as the machine controller or PLC).

Each **NRG BUS** chain consists of the following 3 components:

- the NRG controller
- the NRG solid state relay(s)
- the NRG internal BUS cables

The **NRG controller** is the interface to the machine controller. It acts as the master of the BUS chain when performing specific actions on the respective BUS chain, and acts as a gateway for the communication between the PLC and the RG..N solid state relays. It is not possible to operate the NRG system without the NRG controller.

The NRG controllers available are:

- **NRGC**
The NRGC is a NRG controller with a Modbus RTU interface over RS485. The NRGC is addressed via the assigned Modbus ID (from 1-247). In a NRG system operating on Modbus it is possible to have 247 NRG BUS chains.
- **NRGC-PN**
NRGC-PN is a NRG controller with a PROFINET communication interface. The NRGC-PN is identified by a unique MAC address which is printed on the facade of the product. The GSD file can be downloaded from www.gavazziautomation.com
- **NRGC-EIP**
NRGC-EIP is a NRG controller with an EtherNet/IP communication interface. The IP address is provided automatically via a DHCP server. The EDS file can be downloaded from www.gavazziautomation.com
- **NRGC-ECAT**
NRGC-ECAT is a NRG controller with an EtherCAT communication interface. The ESI file can be downloaded from www.gavazziautomation.com
- **NRGC-MBTCP**
NRGC-MBTCP is a NRG controller with a Modbus TCP communication interface.

System Overview - continued

The **NRG solid state relay** is the switching component in the NRG system. Each **RG..N** integrates a communication interface to exchange data with the machine controller (or PLC). The available RG..Ns that can be used in an NRG system are:

- **RG..D..N**
The RG..D..N are solid state relays for use in an NRG system having the communication interface only for real time monitoring. Control of the RG..N is done via a DC control voltage. It is possible to have maximum 48 **RG..D..Ns** in one NRG BUS chain.
- **RG..CM..N**
The RG..CM..N are solid state relays for use in an NRG system having a communication interface for control of the RG..N through the BUS and for real time monitoring. It is possible to have a maximum of 32 RG..CM..N in one NRG bus chain. There are two variants of the RG..CM..N:
RGx1A..CM..N - the solid state relay with zero cross switching
RGx1P..CM..N - the solid state relay with proportional switching.

For a review of the features available in both variants refer to the table below:

Feature	RGx1A..CM..N	RGx1P..CM..N
External control	●	-
ON / OFF switching	●	●
Burst switching	●	●
Distributed full cycle switching	●	●
Advanced full cycle switching	●	●
Phase angle	-	●
Soft start with time mode	-	●
Soft start with current limit mode	-	●
Voltage compensation	-	●
Monitoring of system parameters	●	●
SSR diagnostics	●	●
Load diagnostics	●	●
Overtemperature protection	●	●

It is not possible to mix RG..D..N and RG..CM..N in the same BUS chain.

The **NRG internal BUS cables** are proprietary cables that connect the NRG controller to the first RG..N in the NRG BUS chain and respective RG..Ns on the BUS. The internal BUS terminator, provided in the same package with the NRG controller, shall be plugged to the last RG..N in the NRG BUS chain.

NRG system required components

Description	Component code	Notes
Solid state relays	RG..N	NRG solid state relays
NRG controller	NRGC..	<ul style="list-style-type: none"> • NRGC: NRG controller with Modbus RTU communication. • NRGC-PN: NRG controller with PROFINET communication. • NRGC-EIP: NRG controller with EtherNet/IP communication. • NRGC-ECAT: NRG controller with EtherCAT communication. • NRGC-MBTCP: NRG controller with Modbus TCP communication. 1x RGN-TERMRES is included in the NRGC.. packaging. The RGN-TERMRES is to be mounted on the last RG..N on the bus chain.
NRG internal BUS cables	RCRGN-xxx	Proprietary cables terminated at both ends with a micro USB connector

 **List of contents****NRGC**

References	5
Structure	6
General data	7
Dimensions	7
Power supply specifications.....	7
Auxiliary relay specifications.....	8
Internal bus	8
Compatibility and conformance	9
Environmental specifications	10
LED indicators	10
Alarm management	11
Connection diagram.....	11
Mounting	12
Connection specifications	13

RCRGN	14
--------------------	-----------

References

Order code



NRGC

Carlo Gavazzi compatible components

Description	Component code	Notes
Solid state relays	RG..N	<p>NRG solid state relays</p> <ul style="list-style-type: none"> RG..D..N: Communication interface for real time monitoring, DC control for switching ON/OFF the RG..N. Maximum 48x RG..D..N in one BUS chain. RG..CM..N: Communication interface for control of the RG..N and for real time monitoring. Maximum 32x RG..CM..N in one BUS chain.
NRG Internal BUS cables	RCRGN-010-2	10cm cable terminated at both ends with a microUSB connector. Packed x4 pcs.
	RCRGN-025-2	25cm cable terminated at both ends with a microUSB connector. Packed x1 pc.
	RCRGN-075-2	75cm cable terminated at both ends with a microUSB connector. Packed x1 pc.
	RCRGN-150-2	150cm cable terminated at both ends with a microUSB connector. Packed x1 pc.
	RCRGN-350-2	350cm cable terminated at both ends with a microUSB connector. Packed x1 pc.
	RCRGN-500-2	500cm cable terminated at both ends with a microUSB connector. Packed x1 pc.

Further reading

Information	Where to find it	
User manual	http://www.gavazziautomation.com/docs/mt_gh/SSR_UM_NRG.pdf	
Datasheet RG..D..N solid state relay with real time monitoring via bus	http://www.gavazziautomation.com/docs/mt_gh/SSR_RG_D_N.pdf	
Datasheet RG..CM..N solid state relay with control and real time monitoring via bus	http://www.gavazziautomation.com/docs/mt_gh/SSR_RG_CM_N.pdf	

Structure

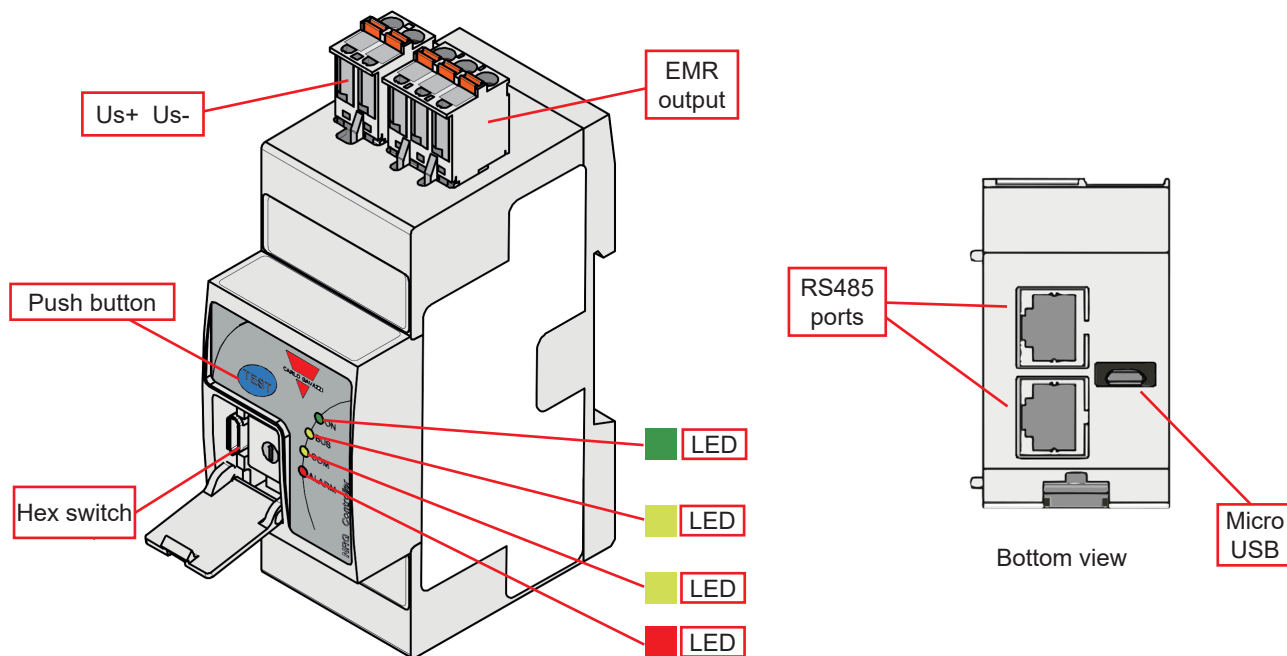

Element	Component	Function
Us+ Us-	Supply connection	2 position spring plug - Us+, Us- connection for powering the NRGC
Push button	Communications check button	Enables and disables a Communications Check function of the BUS chain (link between NRGC and RG..Ns) by pressing front button between 2 to 5 seconds
Hex Switch	NRGC ID hex switch	Sets ID 1 to 15 of the NRGC through a hex switch located behind a door flap that can be opened by a flat screwdriver. Default shipping position = 0 (i.e., internal NRGC ID = 1)
EMR output	Auxiliary Electromechanical relay	3 position electromechanical relay (11, 12, 14) that can function as an Alarm EMR or a general purpose EMR Default shipped function = Alarm EMR
Green LED	ON indicator	Indicates presence of Supply voltage on NRGC
Yellow LED	BUS indicator	Indicates ongoing communication with RG..Ns
Yellow LED	COM indicator	Indicates ongoing communication with main controller
Red LED	ALARM indicator	Indicates presence of an Alarm condition
RS485 ports	RS485 internal communication ports	2x RJ45 (loopable) plugs for RS485 communications line
Micro USB	Micro-USB port – internal BUS	RCRGN cable connection for the internal BUS communications line

Features

General data

Material	Noryl (UL94 V0), RAL7035
Mounting	DIN rail
Dimensions	2-DIN
Touch protection	IP20, IP00 with door flap on front facade open
Weight	135 g
Compatibility	RGC..N solid state contactors (RG end-devices) RGS..N solid state relays (RG end-devices)

Dimensions

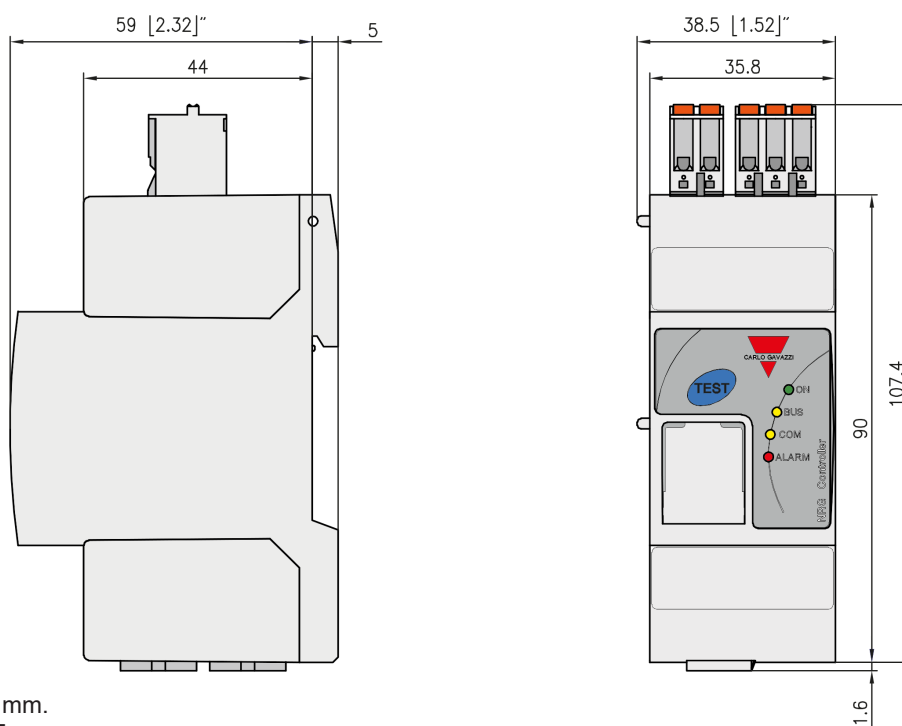

All dimensions in mm.
Tolerances +/- 0.5 mm.

Performance

Power supply specifications

Supply port rating, Us	24 VDC
Supply voltage range, Us	19.2 – 32 VDC*
Reverse polarity protection	Yes
Consumption	< 12 W
LED Indication, Supply ON	Green LED
Power on, Power off delay	<500 ms. No messages are accepted during this time

* to be supplied by class 2 power source according to UL1310

Auxiliary relay specifications

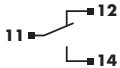
Function	Alarm EMR (default setting): operates in case of an Alarm condition present on the NRGC or General Purpose EMR: operation controlled through ModBus This is configurable via the Relay Configuration Register - refer to NRG User Manual for further details
Output type	EMR, 1 Form C Normally closed (11-12) Normally open (11-14) 
Contact rating	2A @ 250 VAC/30 VDC
Isolation	11, 12, 14 to Us: 1.5k VAC





RS485

Communication protocol to Main Controller	ModBus RTU
Type	2-wire, half duplex
NRGC typology	- ModBus slave using standard Modbus function codes - Byte repeater when main controller addresses RG..Ns directly through the use of a special function code
Baud rate	Default: 115200 bits/s Selectable via ModBus: 9600, 19200, 38400, 57600 and 115200 bits/s
Data Format	Data bits: 8 Parity: Even (Default) Stop bit: 1 Selectable via ModBus: Even, Odd, No parity
Address	Default: 1 (Hex switch position 0) Selectable: 1 to 15 via hex switch Selectable: 1 to 247 via Modbus (with Hex switch position set to 0)
Max. number of NRGCs in the system	247
Connection to main controller	2x shielded RJ45 plugs; 1 plug for interfacing to PLC / main controller 1 plug for looping to another NRGC
LED indication - COM	Yellow, ON indicating ongoing communication with the main controller

Internal Bus

Max. number of RG..Ns connected to NRGC	48x RG..D..N 32x RG..CM..N
Connection to RG..Ns	RCRGN-xx 5-way cable terminated with micro-USB connection
BUS termination	RGN-TERMRES (1x pc. provided with 1x NRGC) to be plugged on the last RG..N on the BUS chain to terminate the internal BUS
LED indication - BUS	Yellow, ON indicating ongoing communication with the RG end-devices

Compatibility and Conformance

Approvals (pending)	   
Standards compliance	LVD: EN 60947-5-1 / EE BSEN 60947-5-1 EMC/CD: EN 60947-5-1 / EMC BSEN 60947-5-1 UL: UL508, E172877, NMFT cUL: C22.2 No. 14-18, E172877, NMFT7

Electromagnetic compatibility (EMC) - Immunity	
Electrostatic discharge (ESD)	EN/IEC 61000-4-2 8 kV air discharge, 4 kV contact (PC1)
Radiated radio frequency	EN/IEC 61000-4-3 10 V/m, from 80 MHz to 1 GHz (PC1) 10 V/m, from 1.4 to 2 GHz (PC1) 3 V/m, from 2 to 2.7 GHz (PC1)
Electrical fast transient (burst)	EN/IEC 61000-4-4 Output: 2 kV, 5 kHz & 100 kHz (PC1) Input: 1 kV, 5 kHz & 100 kHz (PC1)
Conducted radio frequency	EN/IEC 61000-4-6 10 V/m, from 0.15 to 80 MHz (PC1)
Electrical surge	EN/IEC 61000-4-5 DC Output / Input, line to line: 500 V (PC2) DC Output / Input, line to earth: 500 V (PC2) Signal, line to earth 1 kV (PC2) ¹
Voltage dips and interruptions	EN/IEC 61000-4-11 0% @ 5000 ms (PC2) 40% @ 200 ms (PC2) 60% @ 10, 30, 100, 300, 1000 ms (PC2)
Voltage dips and interruptions on input lines	EN/IEC 61000-4-29 0% @ 1, 3, 10, 30, 100, 300, 1000 ms (PC2) 30% @ 10, 30, 100, 300, 1000 ms (PC2) 70% @ 10, 30, 100, 300, 1000 ms (PC2) 80% @ 10, 30, 100, 300, 1000 ms, 3 s, 10 s (PC2) 120% @ 10, 30, 100, 300, 1000 ms, 3 s, 10 s (PC2)





1. Not applicable to shielded cables <10m. Additional suppression on data lines may be required if shielded cables are not used.

Electromagnetic compatibility (EMC) - Emissions	
Radio interference field emission (radiated)	EN/IEC 55011 Class A: from 30 to 1000 MHz
Radio interference voltage emissions (conducted)	EN/IEC 55011 Class B: from 0.15 to 30 MHz

Environmental specifications

Operating temperature	-20 to +65 °C (-4 to +149 °F)
Storage temperature	-20 to +65 °C (-4 to +149 °F)
Relative humidity	95% non-condensing @ 40°C
Pollution degree	2
Installation altitude	0 - 2000m
EU RoHS compliant	Yes
China RoHS	

LED indicators

ON	Green 	ON:	Us is present at terminals Us+, Us-
		OFF:	Us is not present at terminals Us+, Us-
BUS	Yellow 	ON:	During transmission of messages from NRGC to RG..Ns
		OFF:	Idle bus between the NRGC and RG..Ns and when NRGC is receiving data from RG..Ns
COM	Yellow 	ON:	During transmission of a reply from the NRGC to the main controller
		OFF:	Idle bus between the main controller and NRGC and when NRGC is receiving data from the main controller
ALARM	Red 	ON:	Flashing when alarm condition is present. Refer to Alarm management section
		OFF:	No alarm condition

Alarm management

Alarm condition present	<ul style="list-style-type: none"> • Red LED ON with a specific flashing rate • Any of the error flags in NRG status register (CTRSR) is set • Auxiliary relay operates if: <ul style="list-style-type: none"> - It is set as an Alarm relay (shipped default operation) - Respective alarm bit is not masked in the Relay Configuration Register (RLYCR). Refer to NRG user manual for further details 	
Alarm types	No. of flashes	Description of fault
	2	Configuration Error: The number of RG..Ns connected to the bus chain is not correct <ul style="list-style-type: none"> - The number of RG..Ns on the bus chain is >48 for RG..D..N or >32 for RG..CM..N (Device Limit Error) - The number of RG..Ns on bus chain is not as expected (Device Mismatch Error). This alarm is not generated automatically but can be optionally set by the user
	3	Communication Error (COM): An error in the communication link (RS485) between the main controller and the NRG
	8	Communication Error (BUS): An error in the communication link (internal BUS) between the NRG and RG..Ns
	9	Internal Error: Supply out of range or detection of abnormal conditions
	10	Termination (BUS) Error: Internal BUS chain not terminated
Flashing rate		

Connection diagram

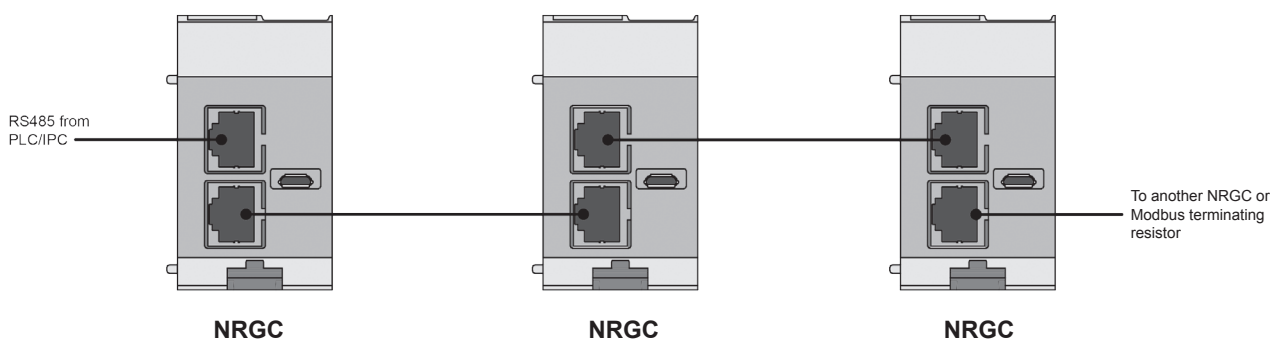

Mounting

Mounting on DIN rail

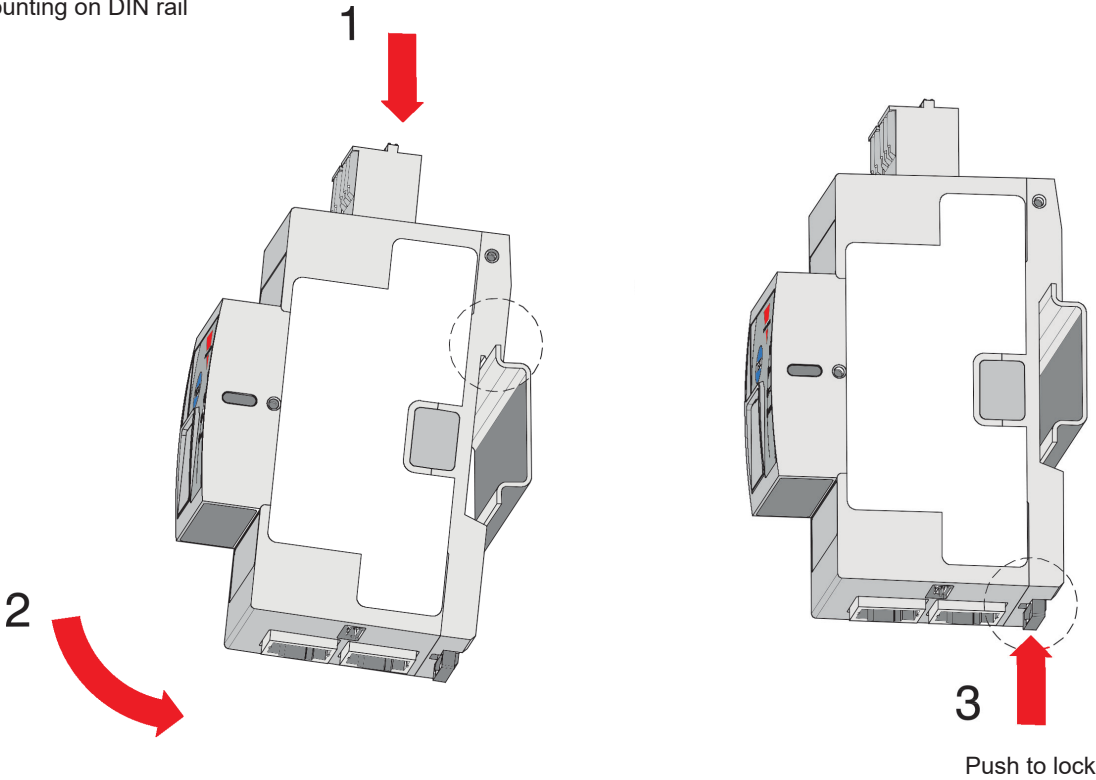

Dismounting from DIN rail

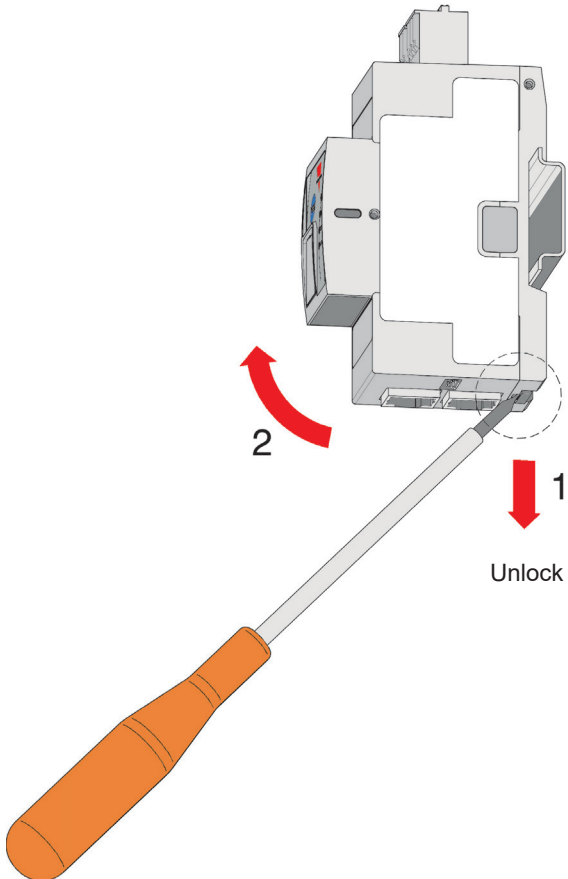

Connection specifications

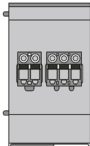
Power connection	
Terminal	Supply: Us+, Us- Auxiliary EMR: 11, 12, 14
	 Top view
Conductors	Use 60/75°C copper (Cu) conductors
Stripping length	12 - 13 mm
Connection type	Spring plug, pitch 5.08 mm 2-pole for Supply 3-pole for Auxiliary EMR (11 Common, 12 Normally Closed, 14 Normally Open)
Rigid (solid & stranded) UL/CSA rated data	0.2 – 2.5 mm ² , 26 – 12 AWG
Flexible with end sleeve	0.25 – 2.5 mm ²
Flexible without end sleeve	0.25 – 2.5 mm ²
Flexible with end sleeve using TWIN ferrules	0.5 – 1.0 mm ²

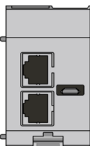
Communication - connection	
Terminal	COM: RJ45 (x2) BUS: RCRGN-xxx-2
	 Bottom view
ModBus RS485 connection	RJ45 shielded plugs, x2 to allow looping
Cable for ModBus	Not provided. Shielded CAT-5e cables are recommended. Connection should be straight, i.e., pin 1 at one end should be connected to pin 1 at the other end. Refer to NRG user manual for further details for the RJ45 connection pin connections.
Max. length of RS485 cable	25 mtrs (this covers the total cable length from the main controller to the last NRGC in the ModBus chain)
Cable for Internal Bus	RCRGN-xxx-2: 5-way USB micro connection - +24 supply line for RG..Ns - GND - RS485A - RS485B - Autoconfig line

RCRGN..

NRG internal BUS cable



Main features

- Cables available at various lengths to provide the internal BUS of the NRG system
- Cables terminated at both ends with a microUSB plug
- Connects the NRG controller to the RG..N solid state relay and respective RG..N solid state relays

Description

The **RCRGN** cables are proprietary cables that must be used with the NRG system for the internal BUS. These cables connect the NRG controller to the RG..N solid state relays and respective RG..N solid state relays.

The RCRGN... are 5-way cables carrying the communication, supply and autocofiguration lines. By means of autoconfiguration, the RG..Ns are assigned a unique ID based on the physical location and hence internal BUS wiring sequence when an autoconfiguration command is sent to the RG..Ns.

Carlo Gavazzi compatible components

Description	Component code	Notes
NRG Controller	NRGC..	<ul style="list-style-type: none"> • NRGC: NRG controller with Modbus RTU communication. • NRGC-PN: NRG controller with PROFINET communication. • NRGC-EIP: NRG controller with EtherNet/IP communication. • NRGC-ECAT: NRG controller with EtherCAT communication. • NRGC-MBTCP: NRG controller with Modbus TCP communication. 1x RGN-TERMRES is included in the NRGC.. packaging. The RGN-TERMRES is to be mounted on the last RG..N on the bus chain.
Solid state relays	RG..N	NRG solid state relays

Order code

RCRGN - - 2

Enter the code entering the corresponding option instead of

Code	Option	Description	Notes	
R	-	Cables		
C	-			
R	-			
G	-		Suitable for the NRG system	
N	-			
<input type="checkbox"/>	010	10 cm cable length	packed x 4 pcs.	
	025	25 cm cable length	packed x 1 pc.	
	075	75 cm cable length	packed x 1 pc.	
	150	150 cm cable length	packed x 1 pc.	
	350	350 cm cable length	packed x 1 pc.	
	500	500 cm cable length	packed x 1 pc.	
2	-	Terminated at the both ends with a microUSB connector		



COPYRIGHT ©2022
Content subject to change.
Download the PDF: <http://gavazziautomation.com>